

Surface Mount General Purpose Rectifier

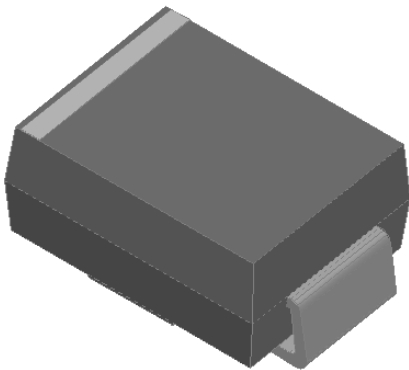

Features

- Low profile package
- Ideal for automated placement
- Glass passivated chip junction
- High forward surge capability
- Meets MSL level 1, per J-STD-020, LF maximum peak of 260 °C

Typical Applications

For use in general purpose rectification of power supplies, inverters, converters, and freewheeling diodes for consumer, and telecommunication.

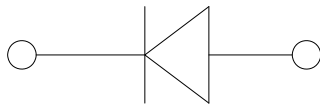

Mechanical Data

- **Package:** DO-214AA (SMB)
Molding compound meets UL 94 V-0 flammability rating, RoHS-compliant, halogen-free
- **Terminals:** Tin plated leads, solderable per J-STD-002 and JESD22-B102
- **Polarity:** Cathode line denotes the cathode end

■ Maximum Ratings (T_a=25°C Unless otherwise specified)

PARAMETER	SYMBOL	UNIT	GS5AB	GS5BB	GS5DB	GS5GB	GS5JB	GS5KB	GS5MB
Device marking code			GS5AB	GS5BB	GS5DB	GS5GB	GS5JB	GS5KB	GS5MB
Maximum Repetitive peak reverse voltage	V _{RRM}	V	50	100	200	400	600	800	1000
Maximum RMS Voltage	V _{RMS}	V	35	70	140	280	420	560	700
Maximum DC Blocking Voltage	V _{DC}	V	50	100	200	400	600	800	1000
Average rectified output current @60Hz sine wave, resistance load, TL (Fig.1)	I _O	A	5.0						
Forward Surge Current (Non-repetitive) @60Hz Half-sine wave, 1 cycle, T _j =25°C	I _{FSM}	A	150						
Forward Surge Current (Non-repetitive) @1ms, square wave, 1 cycle, T _j =25°C			300						
Current squared time @1ms≤t≤8.3ms T _j =25°C	I ² t	A ² s	94						
Storage temperature	T _{stg}	°C	-55 ~ +150						
Junction temperature	T _j	°C	-55 ~ +150						

■ Electrical Characteristics (T_a=25°C Unless otherwise specified)

PARAMETER	SYMBOL	UNIT	TEST CONDITIONS	GS5AB	GS5BB	GS5DB	GS5GB	GS5JB	GS5KB	GS5MB
Maximum instantaneous forward voltage	V _F	V	I _F M=5.0A	1.1						
Maximum DC reverse current at rated DC blocking voltage	I _R	μA	T _j =25°C	5						
			T _j =125°C	100						
Typical junction capacitance	C _j	pF	Measured at 1MHz and Applied Reverse Voltage of 4.0 V.D.C	34						



GS5AB THRU GS5MB

■ Thermal Characteristics (T_a=25°C Unless otherwise specified)

PARAMETER	SYMBOL	UNIT	GS5AB	GS5BB	GS5DB	GS5GB	GS5JB	GS5KB	GS5MB
Typical Thermal resistance	R _{θJ-A}	°C/W	80 ⁽¹⁾						
	R _{θJ-L}		35 ⁽¹⁾						
	R _{θJ-C}		30 ⁽¹⁾						

Note:
 (1) Thermal resistance from junction to ambient and from junction to lead mounted on P.C.B. with 0.3" x 0.3" (8.0 mm x 8.0 mm) copper pad areas

■ Characteristics (Typical)

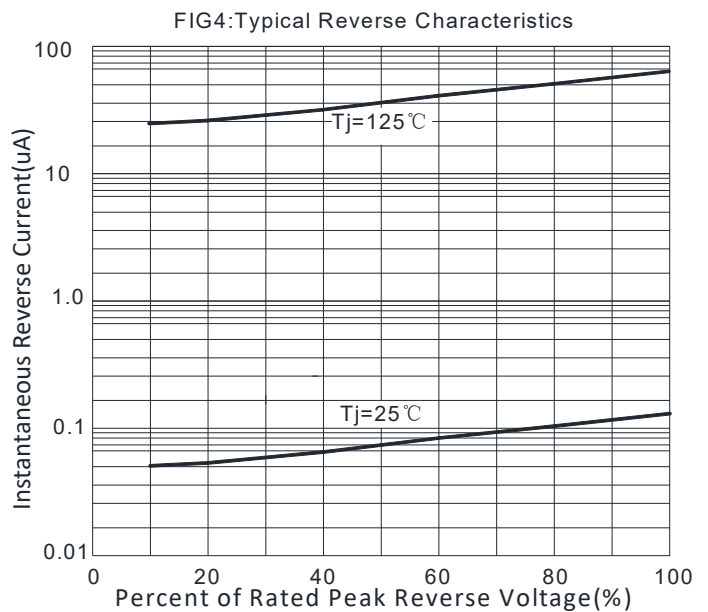
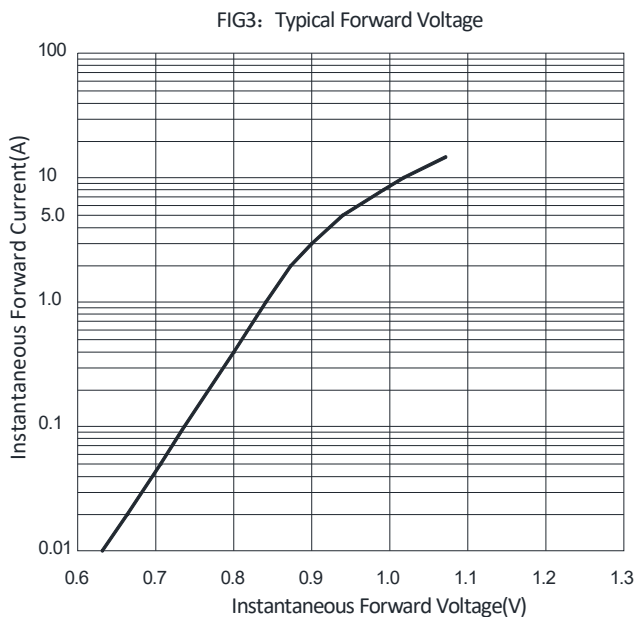
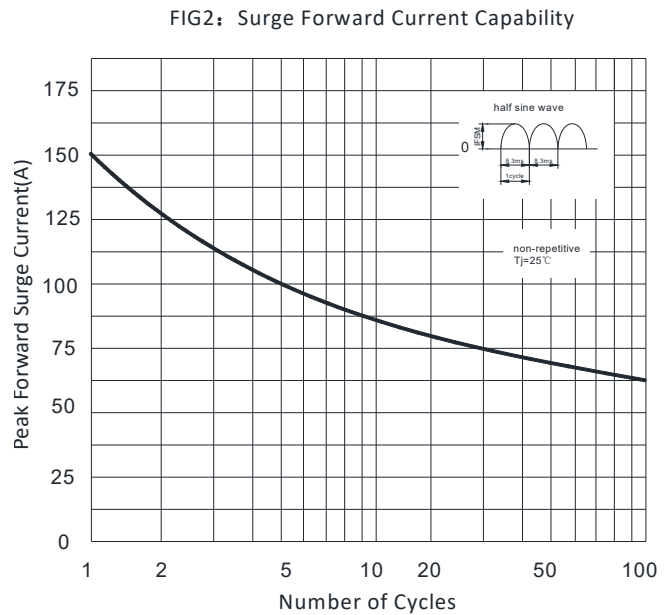
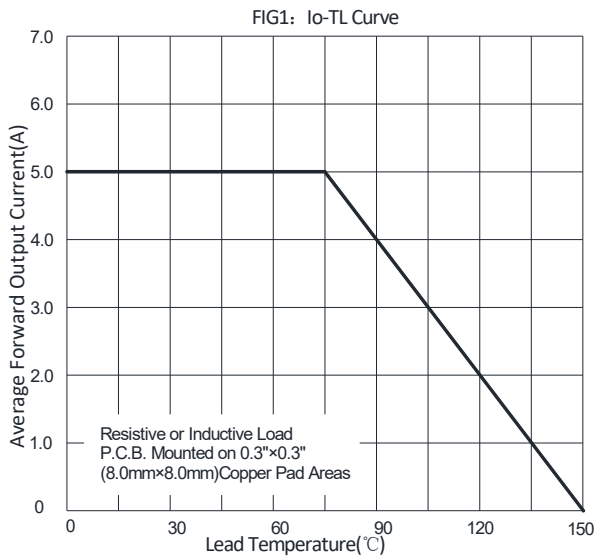



GS5AB THRU GS5MB

FIG.5: Diagram of circuit and Testing wave form of reverse recovery time

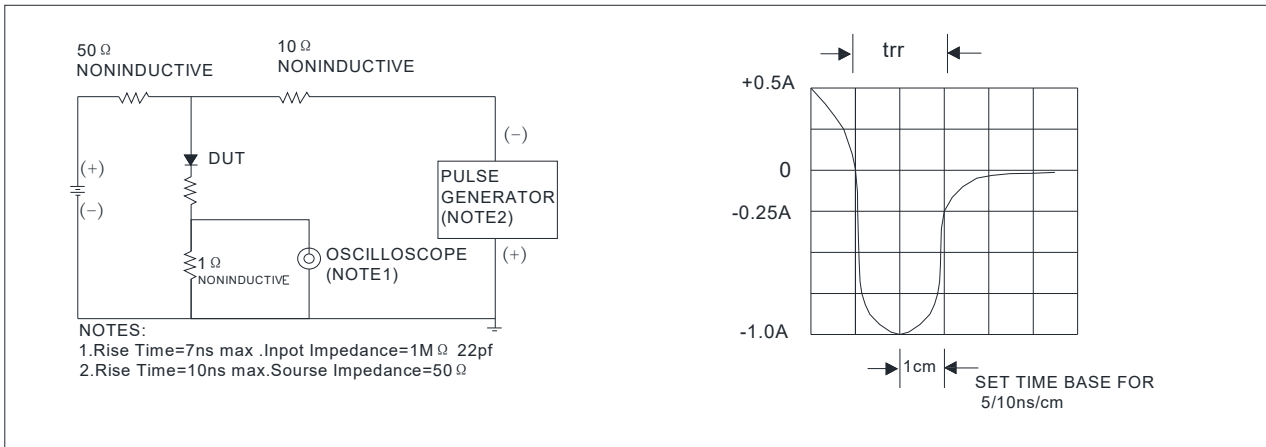

Ordering Information (Example)

PREFERRED P/N	PACKING CODE	UNIT WEIGHT(g)	MINIMUM PACKAGE(pcs)	INNER BOX QUANTITY(pcs)	OUTER CARTON QUANTITY(pcs)	DELIVERY MODE
GS5AB-GS5MB	F1	Approximate 0.096	3000	/	48000	13" reel
GS5AB-GS5MB	F2	Approximate 0.096	750	6000	24000	7" reel
GS5AB-GS5MB	F3	Approximate 0.096	500	4000	16000	7" reel

Outline Dimensions

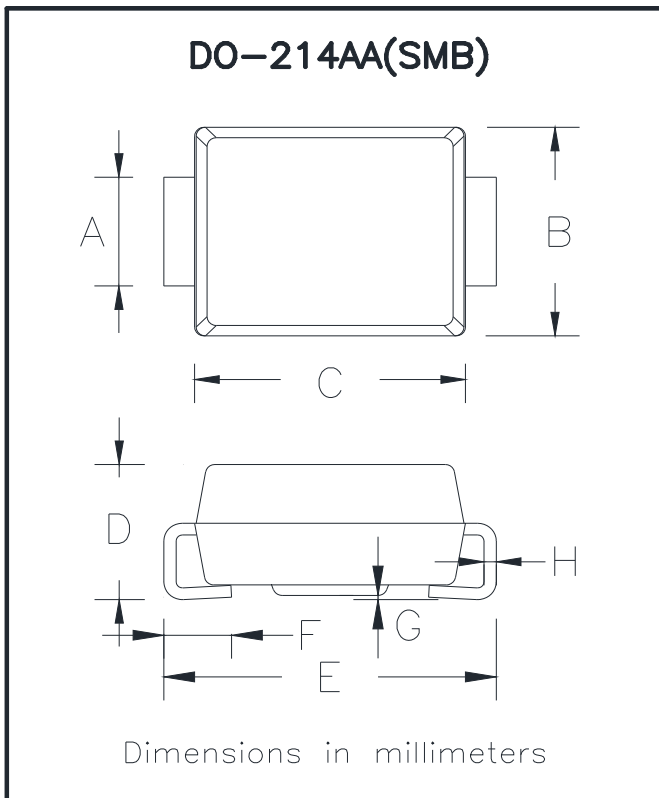

DO-214AA(SMB)		
Dim	Min	Max
A	1.85	2.15
B	3.30	3.94
C	4.05	4.75
D	1.99	2.61
E	5.21	5.59
F	0.90	1.41
G	0.05	0.20
H	0.15	0.31



GS5AB THRU GS5MB

■ Suggested pad layout

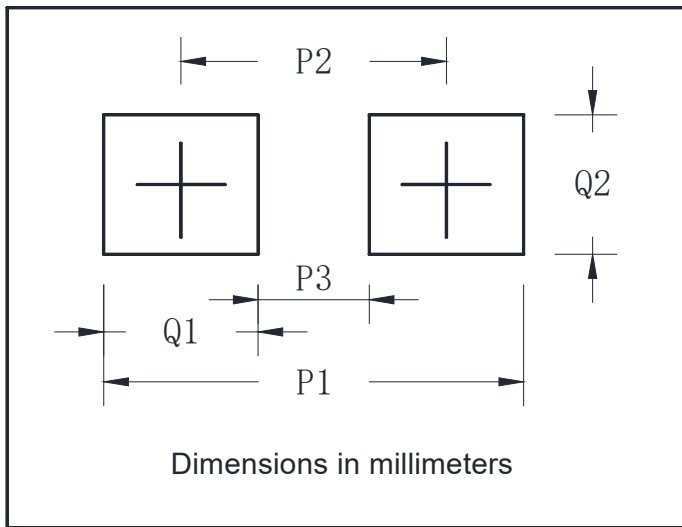

DO-214AA(SMB)	
Dim	Millimeters
P1	6.8
P2	4.3
P3	1.8
Q1	2.5
Q2	2.3



GS5AB THRU GS5MB

Disclaimer

The information presented in this document is for reference only. Yangzhou Yangjie Electronic Technology Co., Ltd. reserves the right to make changes without notice for the specification of the products displayed herein to improve reliability, function or design or otherwise.

The product listed herein is designed to be used with ordinary electronic equipment or devices, and not designed to be used with equipment or devices which require high level of reliability and the malfunction of which would directly endanger human life (such as medical instruments, transportation equipment, aerospace machinery, nuclear-reactor controllers, fuel controllers and other safety devices), Yangjie or anyone on its behalf, assumes no responsibility or liability for any damages resulting from such improper use of sale.

This publication supersedes & replaces all information previously supplied. For additional information, please visit our website [http:// www.21yangjie.com](http://www.21yangjie.com) , or consult your nearest Yangjie's sales office for further assistance.